

## NT 361 Eco M A / NT 611 Eco M A

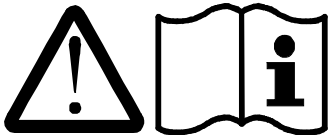

[www.karcher.com](http://www.karcher.com)

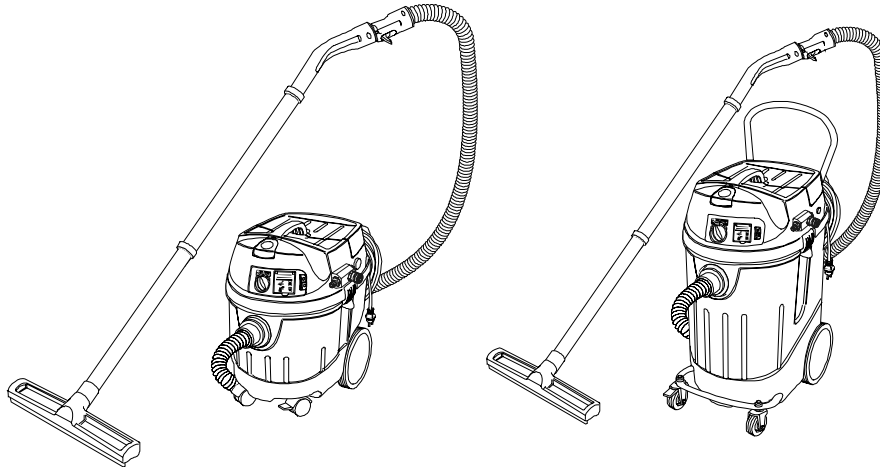
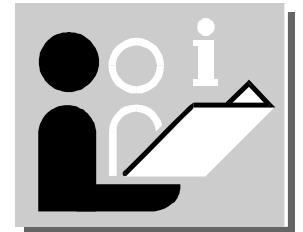

5.960-422 A2006372 07/03

# NT 361 Eco M A / NT 611 Eco M A



Inhaltsverzeichnis	DE	Seite
Inbetriebnahme		5
Betriebsanleitung		7
Kärcher-Niederlassungen		121
Technische Daten / Schaltplan / Ersatzteilliste	122/123/124	
Filtersysteme / Zubehör		126/127

**Vor erster Inbetriebnahme Betriebsanleitung und Sicherheitshinweise Nr. 5.956-251 unbedingt lesen! Dieses Gerät ist für den gewerblichen Gebrauch geeignet, z.B. in Hotels, Schulen, Krankenhäusern, Fabriken, Läden, Büros und Vermietergeschäften.**

Lists of contents	EN	Page
Commissioning		5
Operating Instructions		16
Kärcher branches		121
Technical Data / Wiring diagram / Spare Parts List	122/123/124	
Filter systems / Accessories		126/127

**Prior to initial startup, operating manual and safety instructions no. 5.956-251 must be consulted! This machine is suitable for industrial use, for instance in hotels, schools, hospitals, factories, shops, offices and on hire.**

Tables des matières	FR	Page
Mise en service		5
Notice d'utilisation		25
Filiales Kärcher		121
Caractéristiques techniques / Schéma de câblage /		
Liste des pièces de rechange	122/123/124	
Systèmes de filtres / Accessoires		126/127

**Avant la première mise en service, lire absolument le mode d'emploi et les 5.956-251 remarques de sécurité! Cet appareil est adapté à l'usage professionnel, p. ex. dans les hôtels, les écoles, les hôpitaux, les usines, les magasins, les bureaux et les locations.**

Indici	IT	Pagina
Messa in funzione		5
Istruzioni per l'uso		34
Filiali Kärcher		121
Dati tecnici / Schema elettrico / Elenco pezzi di ricambio	122/123/124	
Sistemi del filtro / Accessori		126/127

**Prima della prima messa in funzione leggere assolutamente le istruzioni per l'uso e le avvertenze per la sicurezza n. 5.956-251! Questo apparecchio è adatto per settori commerciali, per es. hotel, scuole, ospedali, fabbriche, negozi, uffici e noleggi.**

Inhoudsopgave	NL	Pagina
Inbedrijfstelling		5
Gebruiksaanwijzing		43
Kärcher – filialen		121
Technische gegevens / Schakelschema / Reserveonderdelenlijst	122/123/124	
Filtersystemen / Accessoires		126/127

**Vóór de eerste ingebruikneming de gebruiksaanwijzing en de veiligheidsinstructies nr.: 5.956-251 beslist lezen!  
Dit apparaat is geschikt voor professioneel gebruik, bijv. in hotels, scholen, ziekenhuizen, winkels, kantoren en verhuurbedrijven.**

Índices	ES	Paginación
Puesta en servicio		5
Instrucciones de servicio		52
Filiales de Kärcher		121
Datos técnicos / Diagrama de conexiones / Lista de piezas de requesto	122/123/124	
Sistemas de filtros / Accesorios		126/127

**Las instrucciones de servicio y las indicaciones de seguridad núm. 5.956-251 se deben leer imprescindiblemente antes de la primera puesta en servicio!  
Este aparato es apropiado para el uso a escala industrial, p. ej. en hoteles, centros escolares, hospitales, fábricas, tiendas comerciales, oficinas y empresas dedicadas al alquiler.**

# NT 361 Eco M A / NT 611 Eco M A



Índices	PT	Página
Colocação em funcionamento		5
Manual de instruções		61
Filiais da Kärcher		121
Dados técnicos / Esquema de ligações / Lista de peças sobresselentes	122/123/124	122/123/124
Sistemas de Filtro / Acessórios		126/127

Antes da primeira colocação em funcionamento, ler atentamente o manual de instruções e as indicações de segurança nº5.956-251!

Este aparelho destina-se ao uso industrial, nomeadamente em hotéis, escolas, hospitais, fábricas, lojas, escritórios e empresas de aluguer.

Πίνακες περιεχομένων	EL	σελίδα
Θέση σε λειτουργία		5
Οδηγίες λειτουργίας		70
Αντιπροσωπείες Kärcher		121
Τεχνικά χαρακτηριστικά/Κυκλωματικό διάγραμμα/ανταλλακτικά	122/123/124	122/123/124
Συστήματα φίλτρων / εξαρτήματα		126/127

Πριν από την πρώτη θέση λειτουργίας διαβάστε οπωσδήποτε τις Οδηγίες χρήσης και Υποδείξεις ασφαλείας, αρ. 5.956-251!

Αυτή η συσκευή είναι κατάλληλη για την επαγγελματική χρήση, π.χ. σε ξενοδοχεία, σχολεία, νοσοκομεία, εργοστάσια, καταστήματα, γραφεία και εταιρείες δανεισμού συσκευών.

Indholdfortegnelser	DA	Side
Idrifttagning		5
Driftsvejledning		80
Kärcher agenturer		121
Tekniske data / Strømskema / Reservdeliste	122/123/124	122/123/124
Filtersystemer / Tilbehør		126/127

Inden første idrifttagning skal driftsvejledningen og sikkerhedshenvisningerne nr. 5.956-251 læses!

Dette apparat er beregnet til erhvervs-mæssig brug, f.eks. i hoteller, skoler, sygehuse, fabrikker, forretninger, kontorer og udlejningsforretninger.

Innholdsfortegnelser	NO	Side
Igangsetting		5
Bruksveiledning		88
Kärcher filialer		121
Tekniske data / Koplingskjema / Reservdeliste	122/123/124	122/123/124
Filtersystemer / Tilbehør		126/127

Før første gangs bruk må bruksanvisning og sikkerhetsanvisning nr. 5.956-251 ubetinget leses!

Denne maskinen er egnet til bruk i næringslivet, f.eks. i hoteller, skoler, sykehus, fabrikker, butikker, kontorer og utleiebutikker.

Innehållsförteckningar	SV	Sid
Idrifttagning		5
Driftinstruktion		96
Kärcher filialer		121
Tekniska data / Kopplingsschema / Reservdelista	122/123/124	122/123/124
Filtersystem / Tillbehör		126/127

Läs noga instruktionsboken och säkerhetsanvisningarna nr.: 5.956-251 innan aggregatet tas i bruk!

Denna apparat är lämplig för användning inom näringslivet, t.ex. hotell, skolor, sjukhus, fabriker, butiker, kontor och uthyrningsaffärer.

Sisällysluettelo	FI	Sivu
Käyttöönnotto		5
Käyttöohje		104
Kärcher-toimipisteet		121
Tekniset tiedot / Kytentäkaavio / Varaosalista	122/123/124	122/123/124
Suodatinjärjestelmät / Lisävarusteet		126/127

Ennen ensimmäistä käyttöönottoa on käyttöohje ja turvallisuusohjeet numero. 5.956-251 ehdottomasti luettava!

Tämä laite soveltuu ammattimaiseen käyttöön esim. hotelleissa, kouluissa, sairaaloissa, tehtaissa, myymälätiloissa, toimistoissa ja vuokrausliikkeissä.

# NT 361 Eco M A / NT 611 Eco M A



Spis treści	PL	Strona
Uruchomienie		5
Instrukcja obsługi		112
Filie firmy Kärcher		121
Dane techniczne / Schemat ideowy / Lista części zamiennych		122/123/124
Systemy filtracyjne / Wyposażenie dodatkowe /		126/127

**Przed pierwszym uruchomieniem należy koniecznie przeczytać.**

**Instrukcję obsługi i wskazówki dotyczące bezpieczeństwa nr 5.956-251!**  
**do zasysania substancji płynnych.**

**Urządzenie to przeznaczone jest do użytku przemysłowego, np. w hotelach, szpitalach, fabrykach, sklepach, biurach i wypożyczalniach.**

# NT 361 Eco M A

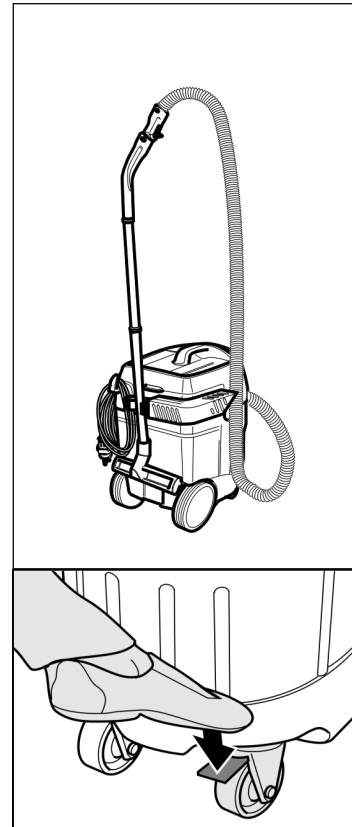
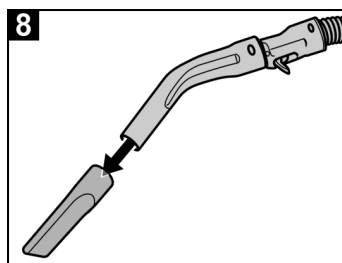
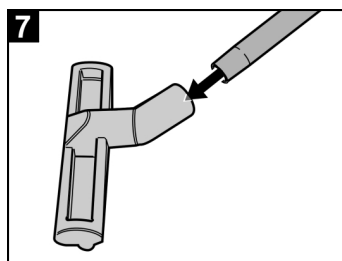
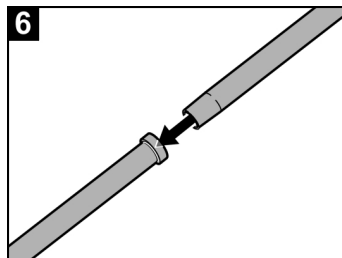
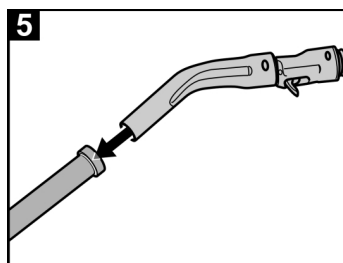
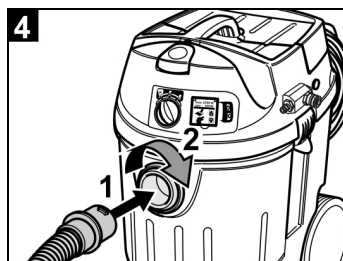
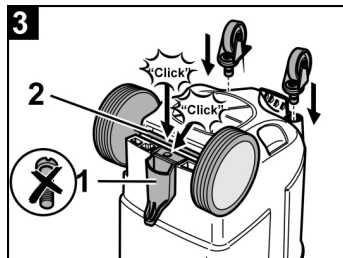
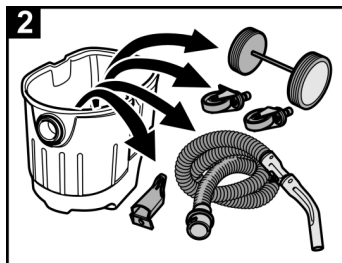
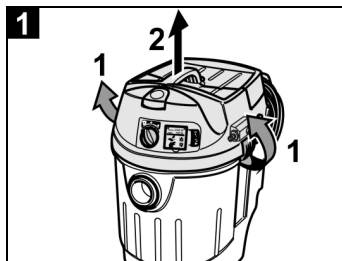
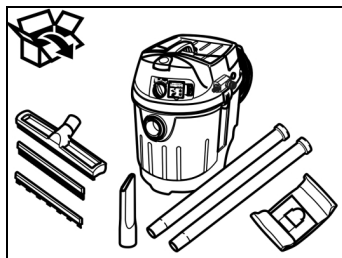

# NT 611 Eco M A

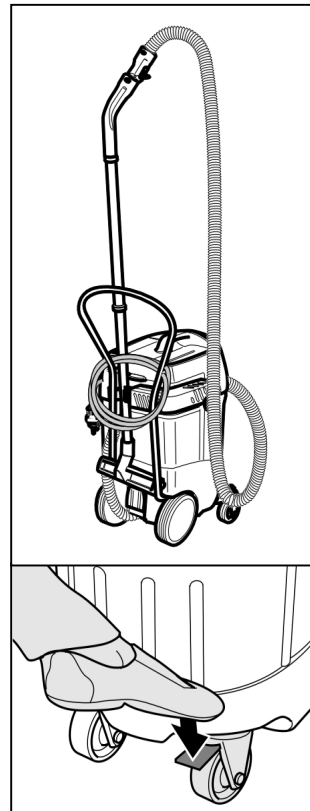
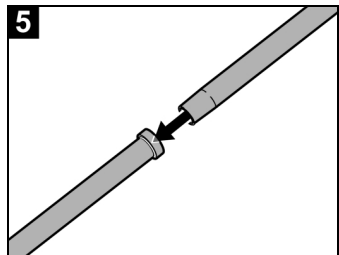
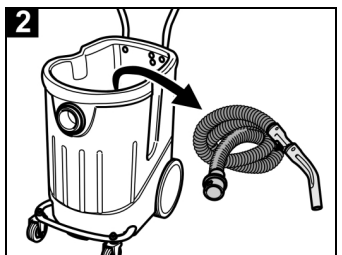
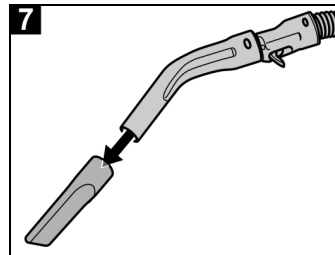
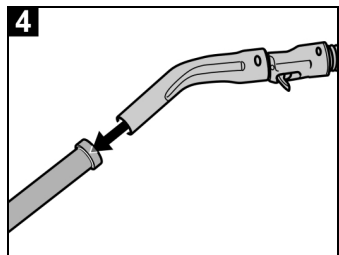
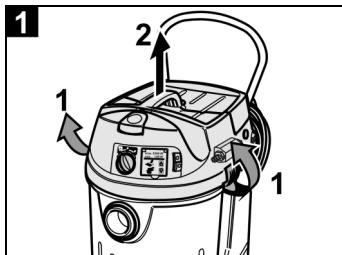
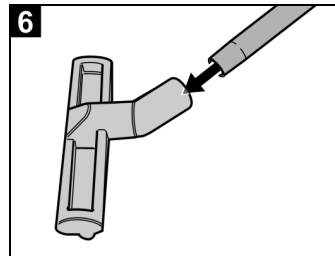
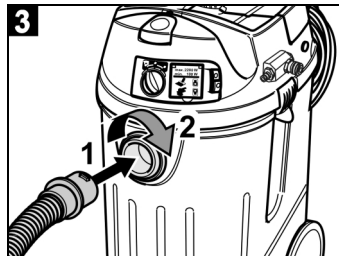
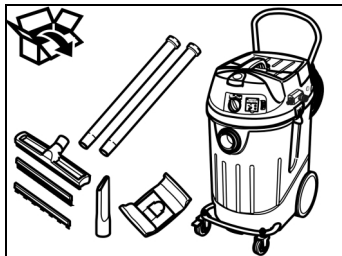

**Important**

The unit is designed to extract dry, non-inflammable, health hazardous dusts at machines and apparatus; dust classification "M" according to EN 60 335-2-69: 1999 annex AA. "H2 suitable for extracting wood dust to a residual dust efficiency of 2; 0,2 mg/m<sup>3</sup> reliably maintained."

**Warning:**

— An adequate ventilation rate (L) is required when the exhaust air is pumped back into the area. To enable maintaining the required limit values the permissible returned volume flow is a maximum of 50% of the fresh air volume flow (room volume V<sub>R</sub> x ventilation rate L<sub>W</sub>). No special ventilation required: L<sub>W</sub>=1h<sup>-1</sup>

- This device contains harmful dust. Emptying and maintenance operations, including disposal of the dust collector, is permissible only by skilled personnel wearing appropriate safety clothing and protection.
- Do not operate the device without the entire filtration system.

**Operating instructions**

**The device has two operating modes:**

- Industrial vacuuming mode (Socket not in use)
- Dust removal (Socket in use)
- Connect suction hose and, depending on operating method, fit vacuuming nozzle or connect it to the dust-producing unit.



**Warning!**

Do not operate the vacuuming device without the filter element, otherwise the vacuum motor will be damaged. This will present a health risk due to the increased amount of fine dust expelled!

**Horn**

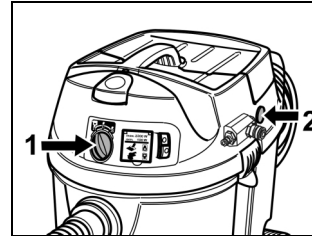

— The horn (2) sounds when the paper filter bag is full

**Note:**

- The horn (2) is activated if the pressure decreases
- The scale (1) must therefore be adjusted to the corresponding cross-sectional size of the vacuum hose.

**Dry suction**

**Manual mode**



**Danger!**

*All dusts up to the M dust classification can be vacuumed with the unit.*



**Danger!**

- The unit is designed as a mobile industrial vacuum cleaner for vacuuming and dust-removing operations to remove dry, non-inflammable, MAC-value dusts.
- The device is fitted with a gauge to indicate any variations in the operating pressure and includes a cleaning function. This ensures that the air speed inside the vacuum hose never falls to below 20 m/s during the vacuuming process.
- The flat folded filter and the paper filter bag must never be removed during vacuuming.

**Fitting the paper filter bag**

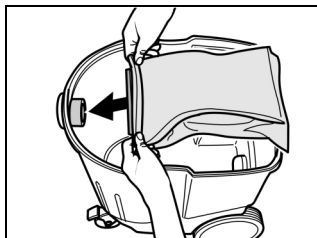

- Unlock and remove the suction head
- Attach the paper filter bag
- Replace the suction head and lock it in place

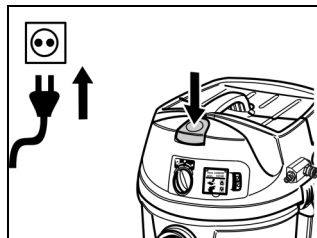

- Insert power plug
- Switch on the machine and start using it

**Automatic operation with a pneumatic and/or a power tool**

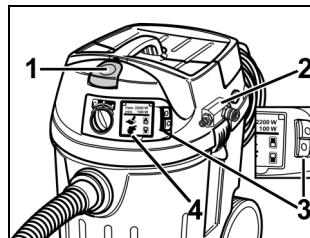

- Switch unit to automatic operation (3)
- Plug power tool's power plug into vacuum cleaner (4) or connect pneumatic tool (2) and open compressed air supply
- Switch on the machine (1)

**Note:**

- The vacuum cleaner is automatically started and stopped when the power tool is turned on and off.
- The vacuum cleaner has a starter delay of up to 0,5 s and an after-running time of up to 15 s.
- See page – technical data - for connected performance data of the tools.

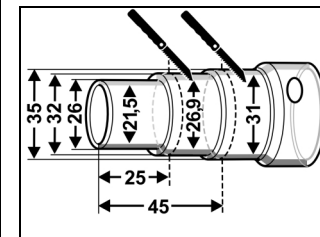

- Adapt the connection sleeve to the electric tool's terminal connection.



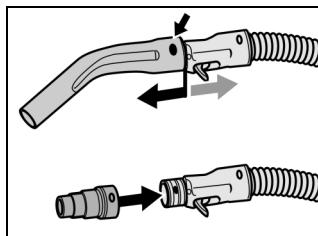

- Remove the pipe bend from the suction hose
- Install the connection sleeve to the suction hose

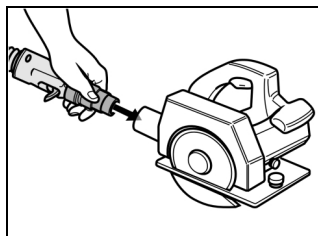

- Connect connecting sleeve to power tool

For pneumatic tool

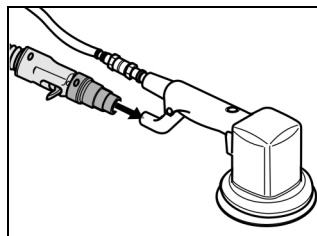

- Connect air hose

Optional accessories for connecting pneumatic tools

Suction hose with integrated air hose

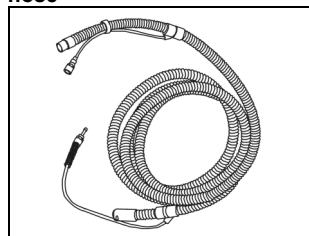

2.860-197

Suction hose with an integrated pneumatic hose especially for Festo air tools

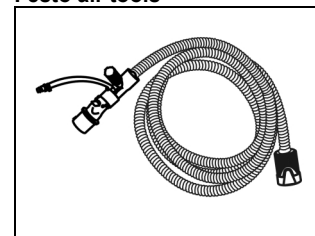

2.860-198



**Warning!**

*Use hose 2.860-198 only if it is attached to an air tool. Direct vacuuming of dirt causes damage to the hose.*

**Grinding accessory set**

2.639-484

**Grinding accessory set, electrically conducting**

2.639-485

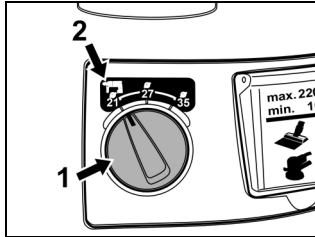

- The minimum volume flow is adjusted using the rotary switch (1).
- The vacuum hose cross-sectional size is indicated on the scales (2).
- Various vacuum hose cross-sectional sizes are required for use on different-sized connection point cross sections on the machinery.

**Note:**

- If the vacuuming device is operated at different locations (i.e. a machine is connected to the suction point), the integrated monitoring device must be adjusted to the connected (dust-producing) machine. This means that the user must be warned if the minimum volume flow required for vacuuming falls below 20 m/s.
- The specified minimum volume flow in relation to the vacuum can be found on the name plate.

**Filter de-duster**

**Power Filter Clean**

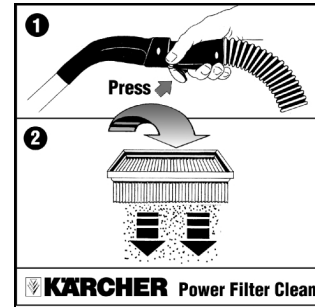

Your vacuum cleaner is provided with a new type of filter cleaner – especially effective for fine dust.

The flat pleated filter is automatically cleaned (pulsing sound) by an air blast if you press the remote control at the hand grip for several seconds.

**Switch Power Filter Clean on**  
Slide setting (1) - downwards

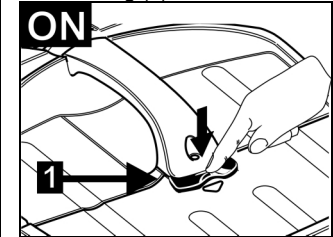

**Warning!**

*Use the Power Filter Clean at regular intervals both during and after completion of the vacuuming operation. The dust-producing machine must be switched off whilst the filter is being cleaned.*

**Wet-vacuuuming**

**Fitting rubber lips**

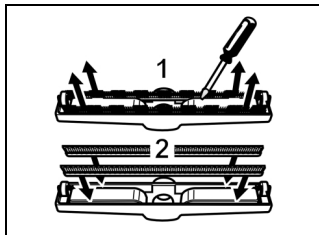

- Fit the rubber lip seals

**Note:**

The profiled surface of the rubber squeegees must be on the outside.

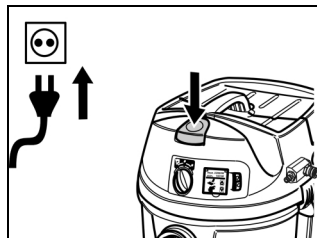

- Remove the paper filter bag
- Insert power plug
- Switch on the machine and start using it

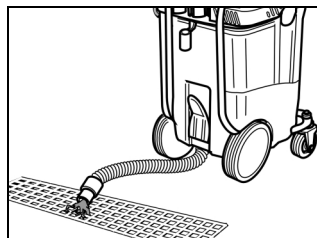

- Drain dirty water using the drain hose

**(Applies only to NT 611 Eco M A)**

**Warning!**

- During vacuuming it is not permitted to ever remove the flat pleated filter.
- The paper filter bag and the membrane filter (optional accessories) respectively must always be removed for vacuuming wet dirt.
- When dielectric liquids are vacuumed (for example. drilling emulsions, oils and grease), the device is not switched off when the container is full. The fill level must be regularly checked and the container emptied before it is too full.

**Switch Power Filter Clean off**  
Setting of the slide (1) - upwards.

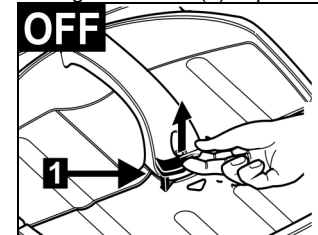

**Note:**

- It is advisable to switch off the - Power Filter Clean - function when vacuuming wet dirt with the upholstery or the crevice nozzles or mainly water out of a container.
- The appliance turns itself automatically off when the max. liquid level has been reached.
- Switch the appliance off and empty the container.
- Clean and dry the flat pleat filter and the electrodes as well as the container after finishing wet vacuuming jobs.

**After completion of an operation**

- Empty dirt collector
- To clean the device, vacuum and wipe the inside and outside
- Store unit in a dry room and secure it against unauthorised use

**Care and maintenance**



**Danger!**

*Always pull out the mains plug when working on the suction machine.*

Dust extracting machines are safeguards for the prevention or elimination of hazards as defined in § 39 in the "General Regulations" of BGV A1.

- For maintenance the user must take the unit apart, clean and service it, as far as this is possible, without causing a hazard to maintenance personnel or third parties.

Appropriate precautionary measures include decontamination prior to taking it apart. Take precautions to provide local filtered forced ventilation where the unit is taken apart. Cleaning the maintenance surface and the provision of suitable protection for personnel.

- The outside of the device should be cleaned thoroughly and any harmful substances removed. Alternatively a sealed coating can be applied before the device is removed from the danger area. It is important to assume that all parts of the device are contaminated when they are removed from the danger area.
- All articles soiled during maintenance and repair work that cannot be satisfactorily cleaned must be thrown away. These parts must be placed in sealed bags and disposed of in accordance with current regulations relating to the disposal of such waste materials.



**Danger!**

*Safety devices which are designed to prevent or eliminate dangerous situations must be serviced regularly. This means that the safety functions of the devices must be subjected to a thorough inspection, e.g. checking for leaks and damage to the filter, and testing the monitoring function. This must be carried out by the manufacturer or a trained person at least once a year. No outside help is required for carrying out basic maintenance and cleaning.*

- The outer surface of the device and the inside of the container should be cleaned regularly using a damp cloth.



**Danger!**

*It is important to observe the following instructions in order to minimise health risks whilst carrying out maintenance work.*

**A respiratory mask P2 or more protection and also disposable clothing must be worn when carrying out maintenance work e.g. changing the filter).**

**Replace the flat pleat filter**

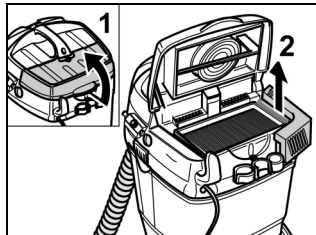

- Open the filter cover (1) and remove the flat folded filter (2). (See imprint on filter element packaging)
- Dispose of the used filter element in a dust-tight, sealed bag in accordance with legal stipulations.
- Remove any accumulations of dirt on the clean-air side
- Replace the flat pleat filter
- Close filter cover, it must audibly engage

— The vacuuming device is fitted with a paper filter bag which has a sliding seal.

**NT 361 Eco M A**  
(manufacture no.: 6.904-210, 5 pieces)

**NT 611 Eco M A**  
(manufacture no.: 6.904-208, 5 pieces)

- If the paper filter bag is full and the volume flow falls below the minimum level the bag must be changed.

**At the end of its service life the device must be disposed of in accordance with legal stipulations.**

**Change the paper filter bag**

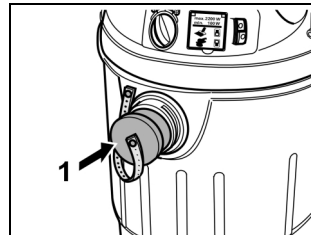

- Insert the connecting sleeve (1) into the suction connector ensuring that it fits tightly
- Slide in the connecting sleeve (1) up to the contact point
- Firmly close the suction connection with the connecting sleeve (1) by turning it clockwise

**Note:**

A proper fit is ensured by the "bayonet connection".

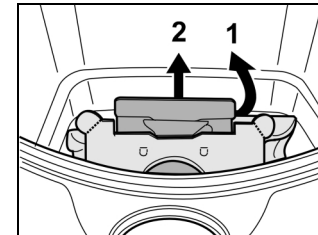

- Remove the paper filter bag by pulling it towards the rear (1)
- Pull sliding cover (2) upwards and tightly seal the paper filter bag as it is removed. (See imprint on filter element packaging)
- Dispose of the used filter element in a dust-tight, sealed bag in accordance with legal stipulations.

**Clean electrodes**

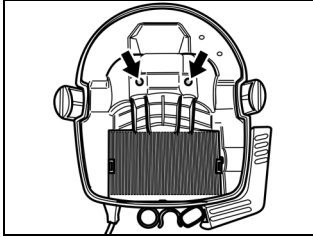

- Unlock and remove the suction head
- Clean electrodes
- Replace the suction head and lock it in place

**Fault instructions**

If a fault occurs (e.g. a torn filter), the device must be switched off immediately. The fault must be remedied before restarting.

**The suction turbine does not run**

- Check the cable, plug, fuse and socket.
- Switch on the machine.

**The suction turbine switches off**

- Empty the container.

**The suction turbine does not restart following emptying of the container**

- Switch the appliance off and wait for 5 s, switch it on again after 5 s.
- Clean the electrodes as well as the space between them.

**The suction power decreases**

- Remove the parts clogging up the suction nozzle, the suction tube, the Power Filter Clean handle, the suction hose or the flat pleat filter.
- Change the paper filter bag.
- Actuate the filter cleaner: Power Filter Clean several times at the handle.
- Engage the filter cover properly.
- Replace the flat pleat filter.

**Dust ejects when sucking**

- Check the proper mounting position of the flat pleat filter.
- Replace the flat pleat filter.

**Automatic cut-out (wet suction) defective**

- Clean the electrodes as well as the space between them.
- Constantly check fill level when vacuuming electrically non-conductive liquids.

**Power Filter Clean switches regularly**

- Detach blocked suction nozzle or end of hose.
- Stop continuous vacuuming from liquid-containing container or switch off - Power Filter Clean – function (see chapter on wet vacuuming).
- Remove the parts clogging up the suction nozzle, the suction tube, the Power Filter Clean handle, the suction hose or the flat pleat filter.
- Replace the flat pleat filter.

**EC conformity declaration**

We hereby declare that the machine specified below as the marketed design, the machine specified below complies with the relevant fundamental safety and health requirements of the EC directives listed below.

Modification of the machine without our approval invalidates this declaration.

Product: Wet/dry vacuum  
 Type: 1.145-xxx 1.146-xxx  
 1.184-xxx

**Relevant EC directives**

EC machine directive (98/37/EC)  
 EC low voltage directive (73/23/EEC) amended by 93/68/EEC  
 EC directive on electromagnetic compatibility (89/336/EEC) amended by 91/263/EEC, 92/31/EEC, 93/68/EEC

**Applied harmonised standards**

DIN EN 60335-1  
 DIN EN 60335-2-69  
 DIN EN 61000-3-2:2000  
 DIN EN 61000-3-3:1995 + A1:2001  
 DIN EN 55014-2:1997  
 DIN EN 55014-1:2000 + A1:2001

**Applied national standards**

GS-HO-07

Internal measures ensure that the in series produced units always comply with the requirements of current EC directives and applied standards. The signatories act for and in authority of management.

5.957-652 (02/02)

Alfred Kärcher Limited Partnership.  
 Registered office: Winnenden.  
 Registration court: Waiblingen, HRA 169.  
 Personally liable partner. Kärcher Reinigungstechnik GmbH.  
 Registered office Winnenden, 2404 Waiblingen Company Register, HRB

Managing directors:  
 Dr. Bernhard Graf,  
 Hartmut Jenner, Georg Metz

Alfred Kärcher GmbH & Co. KG  
 Cleaning Systems  
 Alfred-Kärcher-Strasse 28-40  
 P.O.Box 160  
 D-71349 Winnenden  
 Phone: ++49 7195 14-0  
 Fax :++49 7195 14-2212

  
 (Reiser Jenner)

## NT 361 Eco M A / NT 611 Eco M A

### AT

Alfred Kärcher Ges. m.b.H.  
Lichtblaustraße 7  
A-1220 Wien

### AU

Kärcher (Pty.) Ltd.  
2/158 Browns Road  
Noble Park 3174  
Melbourne, Vict.

### BE, LU, NL

Kärcher Benelux  
Industrieweg 12  
2320 Hoogstraden

### BR

Kärcher Indústria e Comércio Ltda.  
Av. Prof. Benedicto Montenegro

n°419

Paulinia – Estado de Sao Paulo  
CEP 13.140-000

### CA

Kärcher Cleaning Systems Inc.  
1770 Alstep Drive  
Mississauga, Ontario L5S1W1

### CH

Kärcher Variorapid AG  
Industriestr. 16  
CH - 8101 Dällikon

### CZ

Kärcher spol. S. r. a.  
Za Mototschnou  
155 00 Praha – Stodůlky

### DE

**Alfred Kärcher GmbH & Co. KG**  
**Vertrieb Deutschland**  
**Friedrich - List - Straße 4**  
**D - 71364 Winnenden**

### DK

Kärcher A/S  
Gejihavegaard 5  
DK – 6000 Kolding

### ES

Kärcher S.A.  
Pol. Industrial Font del Radium  
Calle Doctor Trueta 6-7  
E - 08400 Granollers (Barcelona)

### FR

Kärcher S.A.  
Z.A. des Petits Carreaux  
5, avenue des Coquelicots  
F - 94865 Bonneuil s. Marne/CEDEX

### FI

Kärcher Oy  
Yrittäjätie 17  
FIN - 01800 Klaukkala

### GB

Kärcher (U.K.) Ltd.  
Kärcher House  
Beaumont Road  
Banbury Oxon, OX 16 7TB

### GR

Kärcher S.A.  
Cleaning Systems  
99 Aristoutelous & Ioanninon  
GR - 136 71 Aharnes

### HU

Kärcher Hungaria Kft.  
H-2051 Biatorbagy (Vendelpark)  
Tormasret ut 2  
Tel.: +36/23530 Fax.: +36/23530-341  
E-mail: info@kaercher.hu

### HK

Kärcher Ltd.  
Unit 10, 17/FL. APEC Plaza  
49 Hoi Yuen Road  
Kwun Tong, Kowloon

### IT

Kärcher S.p.A.  
Via Elvetia 4  
I - 25050 Cantello (VA)

### JP

Kärcher (Japan) Co., Ltd.  
Irene Kärcher Building  
No. 2, Matsusaka-Daira 3-chome  
Taiwa-cho, Kurokawa-gun  
Miyagi, 981-34, Japan

### NO

Kärcher AS  
PO Box 114 Grorud  
N - 0905 Oslo

### PT

Neoparts  
Comercio e Indústria Automóvel, Lda  
Largo Vitorino Damásio. 10  
1200 Lisabon

### PL

Kärcher Poland Ltd.  
Sp. zo. o.  
Ul. Godlewskiego 22  
30-198 Kraków

### SE

Kärcher AB  
Box 24  
S - 42502 Hisings - Kärra

### USA

Alfred Kärcher Inc.  
P.O. Box 6510  
1600 Cottontail Lane  
Somerset, NJ 08875

### ZA

Kärcher (Pty.) Ltd.  
P.O. Box 2417  
Kempton Park 1620



# NT 361 Eco M A / NT 611 Eco M A

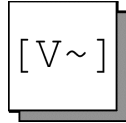

EUR: 230 V / 1~50-60 Hz



1.184-xxx  
1.146-xxx

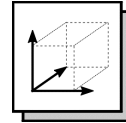

34 l  
55 l  
1.184-xxx:  
510 mm x 430 mm x 535 mm  
1.146-xxx:  
570 mm x 370 mm x 860 mm

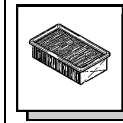

0,5 m<sup>2</sup>

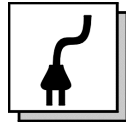

H07RN-F3 x 1,5 mm<sup>2</sup>  
EUR:

7,5 m  
6.648-584

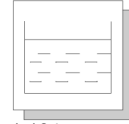

1.184-xxx  
1.146-xxx

20 l  
44 l



-10 °C - +40 °C  
Umgebungstemperatur, Ambient  
temperature, Température ambiante,  
Temperatura del entorno



68 dB(A)

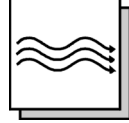

1.184-xxx  
1.146-xxx

125 m<sup>3</sup>/h  
125 m<sup>3</sup>/h

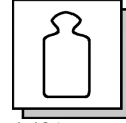

1.184-xxx  
1.146-xxx

10,5 kg  
15,0 kg

30 % - 90 %  
rel. Luftfeuchtigkeit, rel. humidity,  
humidité relative, rel. Humedad del  
aire

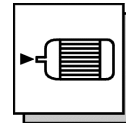

P max:  
P nenn:

1380 W  
1200 W

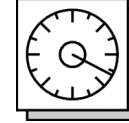

1.184-xxx  
1.146-xxx

max. 210 mbar  
max. 210 mbar

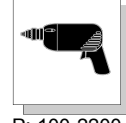

P: 100-2200 W  
min.  
max.  
min.

4 bar  
6 bar  
200 l/min.

Typenschild, Type plate  
Plaque signalétique, Placa de tipo

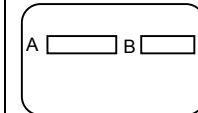

A: Seriennummer, Serial number,  
Numéro de série, Número de serie  
B: Baujahr, Year of construction,  
Année de construction, Año de  
la construcción

# NT 361 Eco M A / NT 611 Eco M A

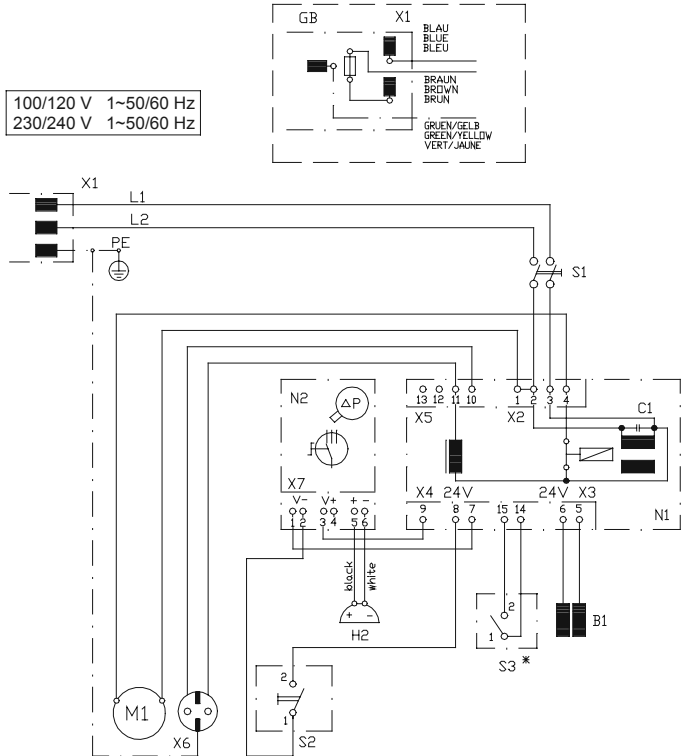

- B1 Elektroden  
Electrodes  
Electrodes
- C1 Entstörkondensator  
Suppression Capacitor  
Condensateur Antiparasites
- H2 Summer  
Buzzer  
Vibreur Sonde
- M1 Saugturbine  
Suction Turbine  
Turbine d'aspiration
- N1 Platine  
Circuit Board  
Platine
- N2 Platine M oder H Sauger  
Circuit M or H suction apparatus  
Platine M ou H aspirateur
- S1 Schalter Turbine  
Switch Suction Turbine  
Interrupteur de Turbine
- S2 Umschalter Betriebsart  
Switch  
Inverseur
- X1 Stecker  
Plug  
Fiche
- X2 } Steckkupplung  
X7 } Plug-In Coupling  
Raccord Prise
- X6 Steckdose  
Socket  
Prise de Courant
- \*S3 Reedschalter  
Reed switch  
Reed Interrupteur

# NT 361 Eco M A / NT 611 Eco M A

## NT 361 ECO M A

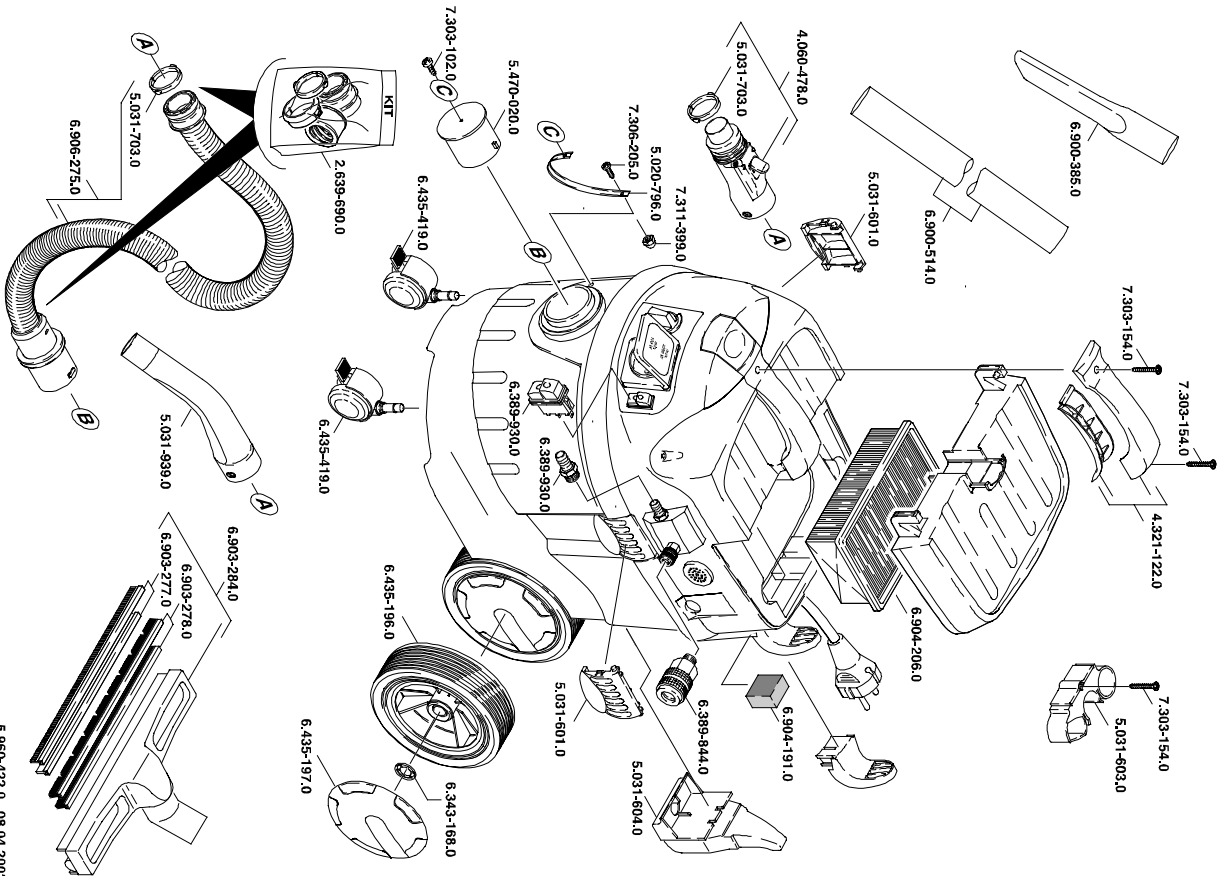





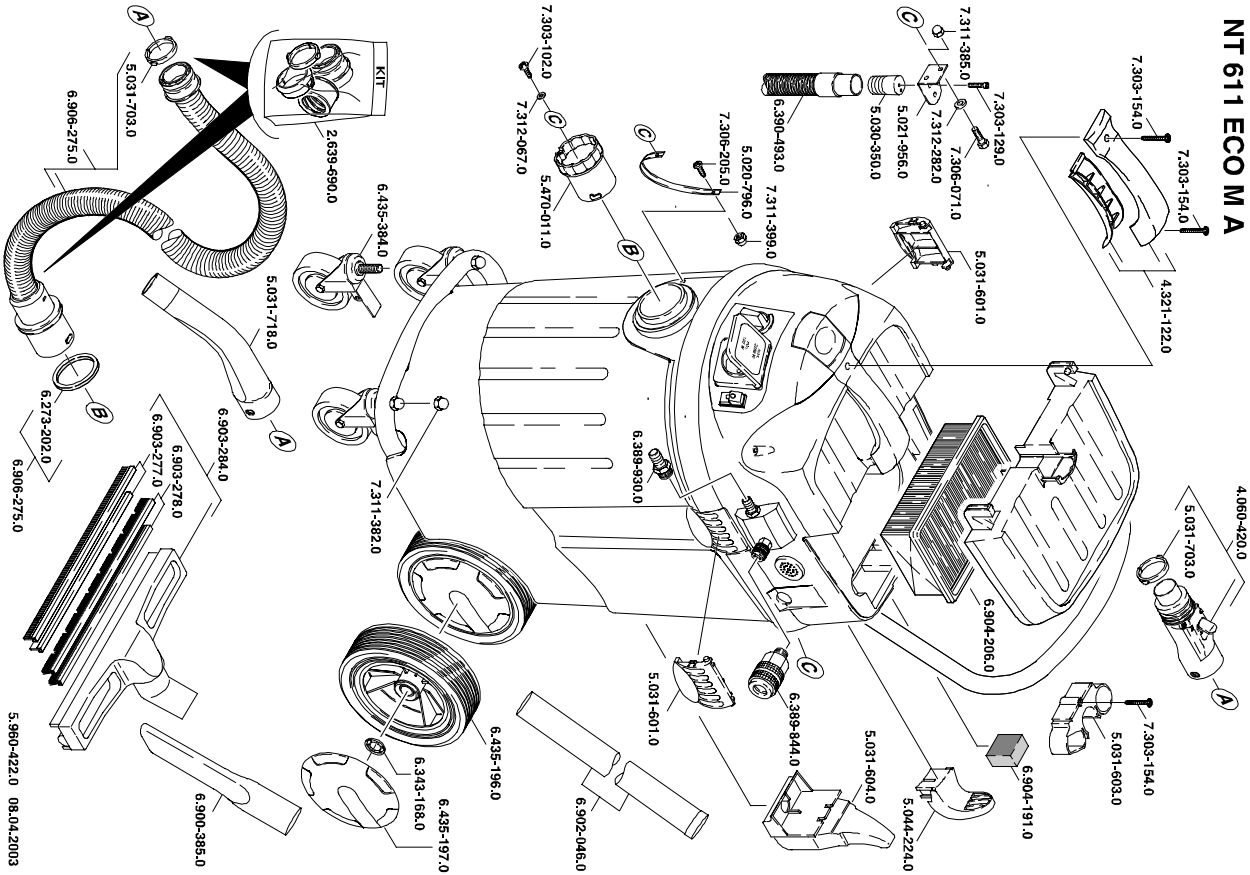











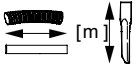

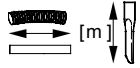







# NT 361 Eco M A / NT 611 Eco M A

## NT 611 ECO M A



## NT 361 Eco M A / NT 611 Eco M A

* BIA C geprüft; Rückhaltevermögen ≥ 99,9 % * BIA C approved; Retention ≥ 99,9 % * Contrôle BIA C; Conservation ≥ 99,9 %		Bestell-Nr. Order No.		Menge Quantity Quantité	Normalstäube Normal dust Poussières normales	Feinstäube Fine dust Poussières fines	Abrasive Stäube Abrasive dust Poussières abrasives	Flüssigkeiten / nasser Schmutz Liquids / wet dirt Liquides / saletès humides
		Numéro de référence						
		NT 361 Eco/TE NT 361 Eco M NT 361 Eco M A NT 361 Eco TEA	NT 561 Eco/TE NT 561 Eco M NT 611 Eco/TE NT 611 Eco M A NT 611 Eco TEA					
	Flachfilter * Flat pleated filter * Filtre plat à plis *	6.904-206	6.904-206	1	X	X	X	
	Papierfiltertüte 2-lagig * Paper filter bag double layered * Sachet filtre à 2 épaisseurs *	6.904-210	6.904-208	5	X		X	
	Membranfilter Diaphragm filter Filtre à membrane	6.904-212	6.904-212	1	X	X	X	
	Spezialfiltertüte / nass Special filter bag / wet Sachet filtre spécial / mouillé	6.904-171	6.904-211	5			X	X
	Flachfilter * (PES) Flat pleated filter * (PES) Filtre plat à plis * (PES)	6.904-190	6.904-190	1				X

		∅ [m m]					∅ [m m]		
	4.440-626 4.440-653	CDN 35 CDN 35 EL	2,5 2,5				6.905-875 6.903-037 6.900-231	DN 35 DN 35 DN 35	360 370 400
	4.440-627 4.440-654	CDN 35 CDN 35 EL	2,5 2,5				6.900-109 6.906-387	DN 35 DN 35	250 270
	4.440-420 4.440-478	C 35 C 35 EL					6.905-531 6.900-385	DN 35 DN 35	0,165 0,25
	6.906-208 6.906-241 6.906-242	C 35 C 35 C 35	2,5 4,0 10,0				6.902-104	DN 35	0,20
	6.906-237 6.906-277	C 35 C 35 EL					6.900-697	DN 35	
	2.639-483	DN 35	0,45				6.900-425	DN 35	0,25
	2.639-484 2.639-485	DN 35/27 DN 35/27 EL	3,5 3,5			EL = elektrisch leitend    C = Clip-Verbindung    DN = Konus-Verbindung electrical conductive    Clip connection    Cone connection conducteur électrique    Connexion de clip    Connexion de cône			
	5.453-042 5.453-052	C 35 EL C 35 EL							
	5.031-718 5.031-939	DN 35 DN 35 EL							
	6.900-514	DN 35	0,5						